

DIST	COUNTY	ROUTE	POST MILES TOTAL PROJECT	SHEET No.	TOTAL SHEETS
08	RJV	79	40.45	1	3

REGISTERED CIVIL ENGINEER DATE _____

PLANS APPROVAL DATE _____

THE STATE OF CALIFORNIA OR ITS OFFICERS OR AGENTS SHALL NOT BE RESPONSIBLE FOR THE ACCURACY OR COMPLETENESS OF SCANNED COPIES OF THIS PLAN SHEET.

CALIFORNIA STATE POLYTECHNIC UNIVERSITY POMONA 3801 W. TEMPLE AVE. POMONA, CA 91768

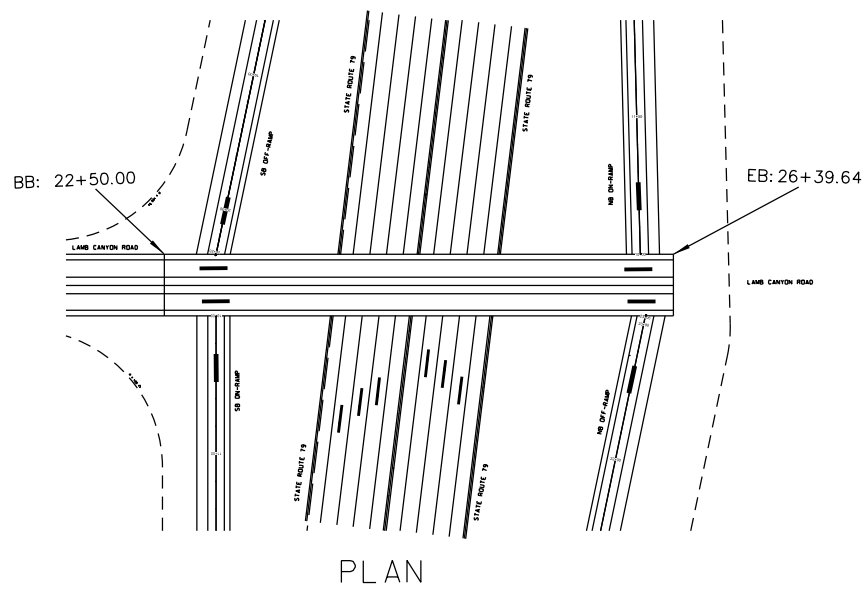
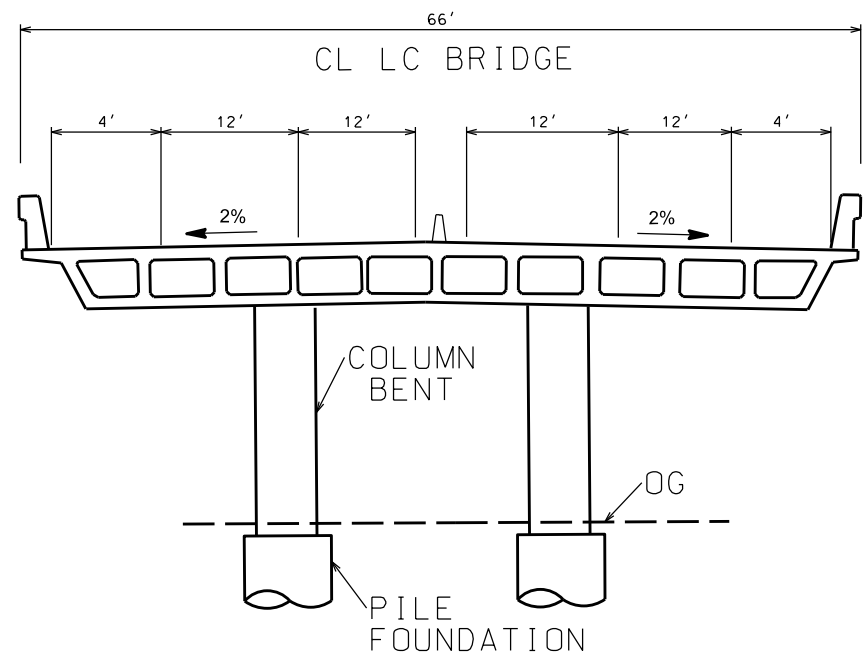
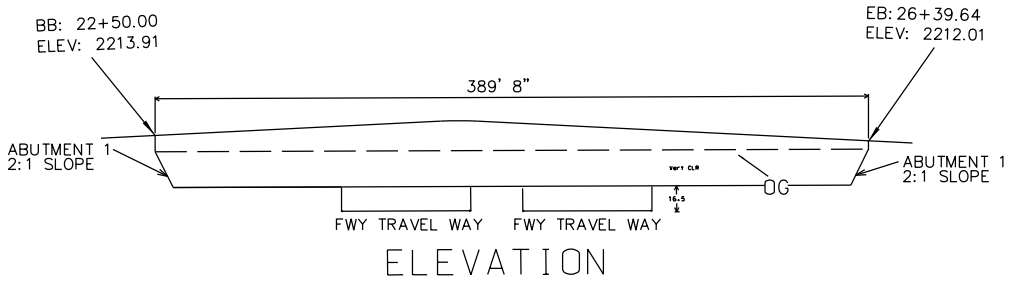
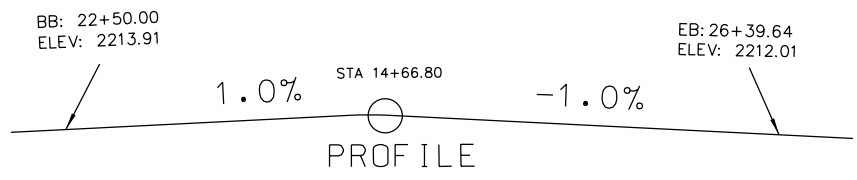
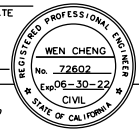

TYPICAL SECTION
LAMB CANYON BRIDGE
PLANNING STUDY



TIGHT DIAMOND INTERCHANGE
LAMB CANYON RD. BRIDGE

STATE OF CALIFORNIA - DEPARTMENT OF TRANSPORTATION
CONSULTANT FUNCTIONAL SUPERVISOR
CALCULATED-DESIGNED BY
CHECKED BY
REVISED BY
DATE REVISED



PROJECT MANAGERS:		PROJECT ENGINEERS					
MATTHEW JACOBSON	CESAR HERNANDEZ	MELISSA WANG	MICHELLE YEH	DOUGLAS ANNAND	BORNA ASAGARI	JOSELYN PERALES	CALLUM MERCHANT
NICOLE AQUINO	BEN COSTELLO	NA LEE	ARODI GARCIA	RAYMOND LI	MIGUEL OBREGON	CONG CHEN	

BORDER LAST REVISED 2/19/2021

DGN FILE => APSBORDER.DGN

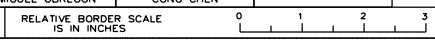

UNIT 4225

PROJECT NUMBER & PHASE

12000001801

LAST REVISION

Dist	COUNTY	ROUTE	POST MILES TOTAL PROJECT	SHEET No.	TOTAL SHEETS
08	RIV	79	40.45	2	3

REGISTERED CIVIL ENGINEER	DATE
	
PLANS APPROVAL DATE	
<small>THE STATE OF CALIFORNIA OR ITS OFFICERS OR AGENTS SHALL NOT BE RESPONSIBLE FOR THE ACCURACY OR COMPLETENESS OF SCANNED COPIES OF THIS PLAN SHEET.</small>	
<small>CALIFORNIA STATE POLYTECHNIC UNIVERSITY POMONA 3801 W. TEMPLE AVE. POMONA, CA 91768</small>	

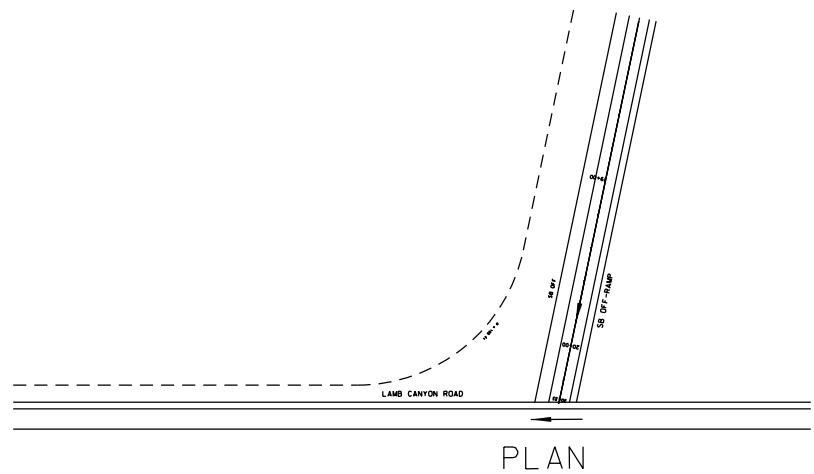
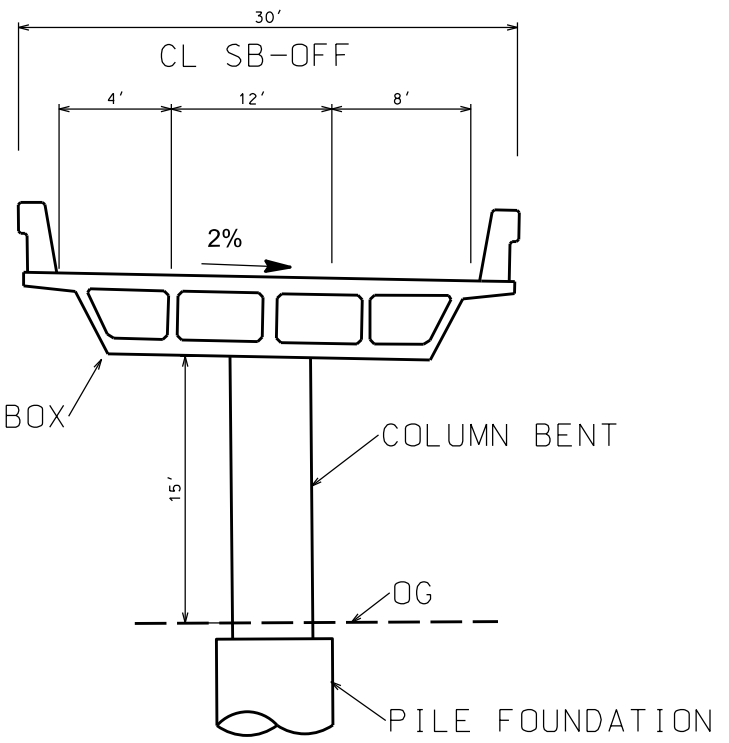
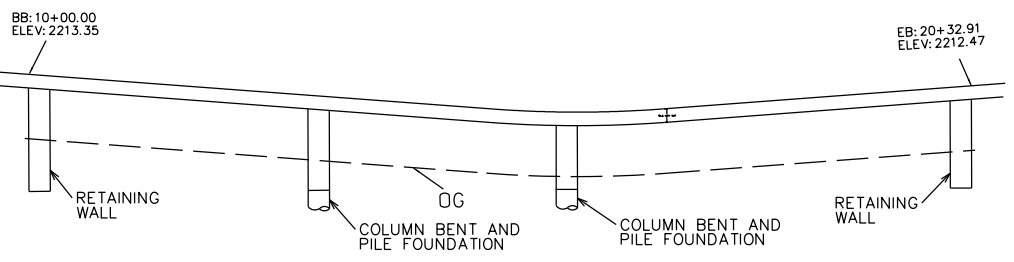
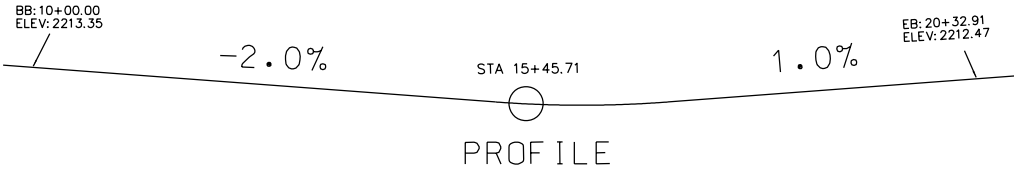

TYPICAL SECTION
SB OFF-RAMP
PLANNING STUDY

TIGHT DIAMOND INTERCHANGE
LAMB CANYON RD. BRIDGE



STATE OF CALIFORNIA - DEPARTMENT OF TRANSPORTATION
 CONSULTANT FUNCTIONAL SUPERVISOR
 DESIGNED BY
 CHECKED BY
 REVISIONS: REVISED BY, DATE, REVISIONS

PROJECT MANAGERS:		PROJECT ENGINEERS					
MATTHEW JACOBSON	CESAR HERNANDEZ	MELISSA WANG	MICHELLE YEH	DOUGLAS ANNAND	BORNA ASAGARI	JOSELYN PERALES	CALLUM MERCHANT
NICOLE AQUINO	BEN COSTELLO	NA LEE	ARODI GARCIA	RAYMOND LI	MIGUEL OBREGON	CONG CHEN	

BORDER LAST REVISED 2/19/2021

DGN FILE => APSBORDER.DGN

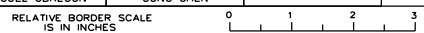

UNIT 4225

PROJECT NUMBER & PHASE

12000001801

LAST REVISION

DIST	COUNTY	ROUTE	POST MILES TOTAL PROJECT	SHEET No.	TOTAL SHEETS
08	RIV	79	40.45	3	3

REGISTERED CIVIL ENGINEER DATE _____

PLANS APPROVAL DATE _____

REGISTERED PROFESSIONAL ENGINEER
WEN CHENG
 No. 72602
 Exp. 06-30-22
 CIVIL
 STATE OF CALIFORNIA

THE STATE OF CALIFORNIA OR ITS OFFICERS OR AGENTS SHALL NOT BE RESPONSIBLE FOR THE ACCURACY OR COMPLETENESS OF SCANNED COPIES OF THIS PLAN SHEET.

CALIFORNIA STATE POLYTECHNIC UNIVERSITY POMONA
 3801 W. TEMPLE AVE.
 POMONA, CA 91768

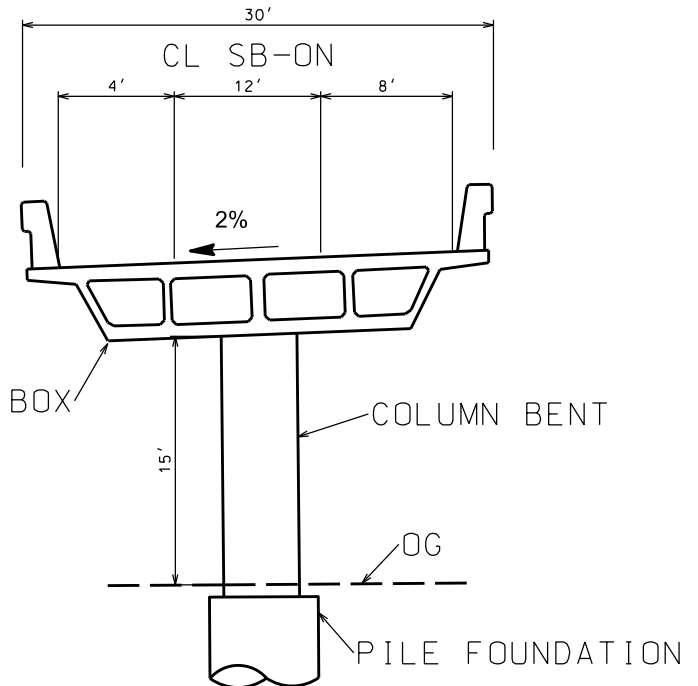
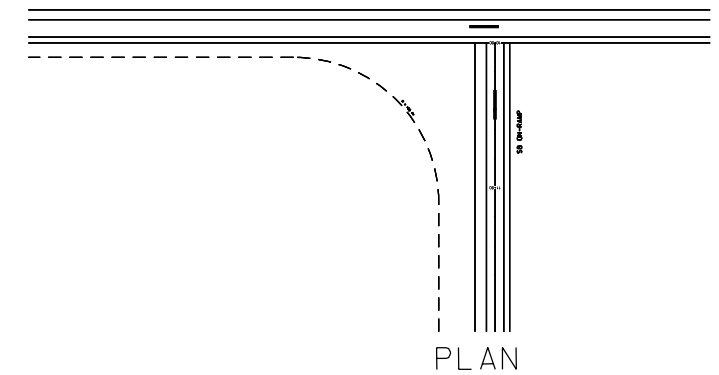
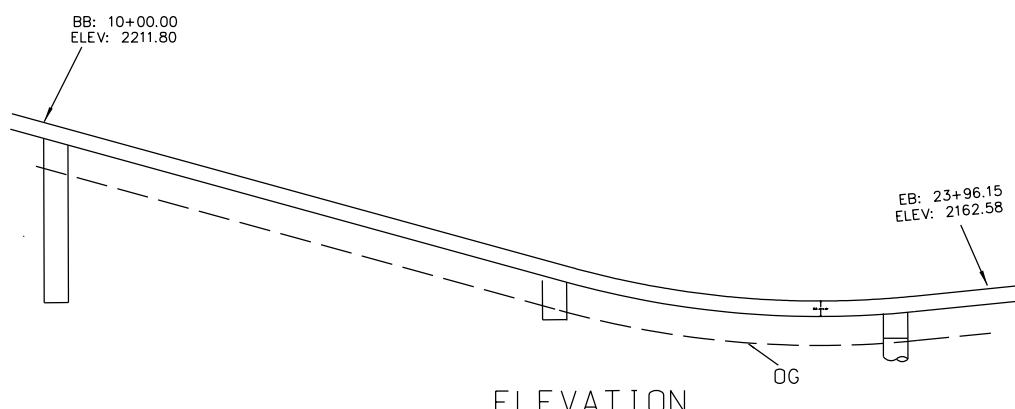
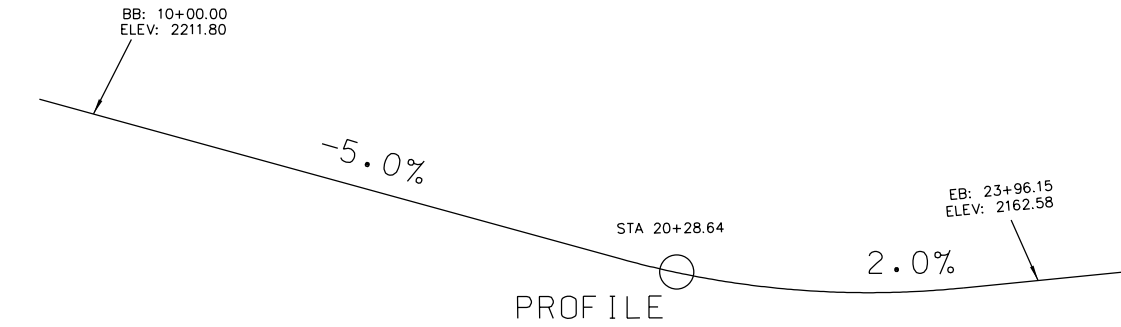

TYPICAL SECTION
 SB ON-RAMP
 PLANNING STUDY

TIGHT DIAMOND INTERCHANGE
 LAMB CANYON RD. BRIDGE



STATE OF CALIFORNIA - DEPARTMENT OF TRANSPORTATION
 CONSULTANT FUNCTIONAL SUPERVISOR
 CALCULATED-DESIGNED BY
 CHECKED BY
 REVISED BY
 DATE REVISED



PROJECT MANAGERS:		PROJECT ENGINEERS					
MATTHEW JACOBSON	CESAR HERNANDEZ	MELISSA WANG	MICHELLE YEH	BORNA ASAGARI	JOSELYN PERALES	CALLUM MERCHANT	
NICOLE AQUINO	BEN COSTELLO	ANA LEE	ARODI GARCIA	RAYMOND LI	MIGUEL OBREGON	CONG CHEN	

BORDER LAST REVISED 2/19/2021

DGN FILE => APSBORDER.DGN

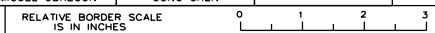

UNIT 4225

PROJECT NUMBER & PHASE

1200001801

LAST REVISION